

ADJUSTABLE FIXTURING COMPONENTS

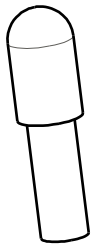

BALL END

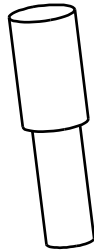

FLAT

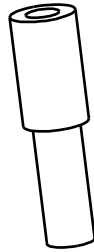

HOLLOW

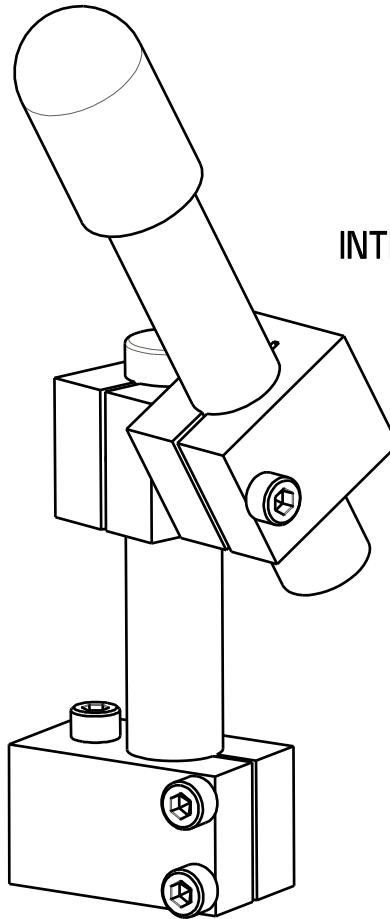

INTERCONNECT
POST

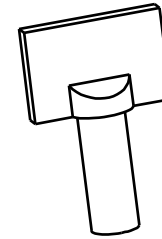

BLADE

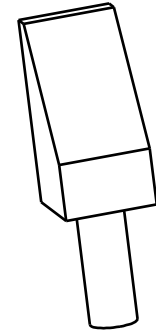

TAPER GUIDE

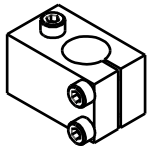

FIXED BASE

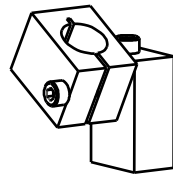

ADJUSTABLE BASE

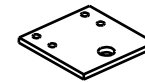

FLAT SENSOR
BRACKET



THREADED POST
FOR
REST BUTTONS

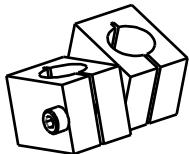

INTERCONNECT JOINT

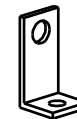

ANGLE SENSOR
BRACKET

